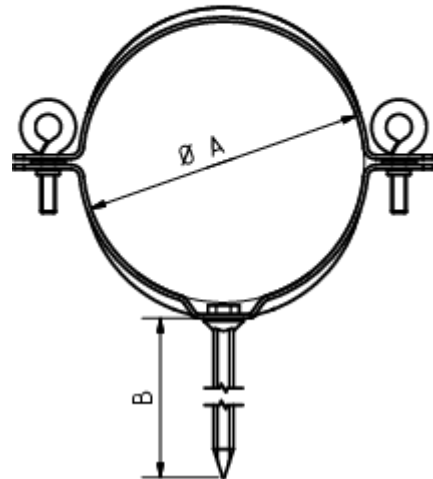
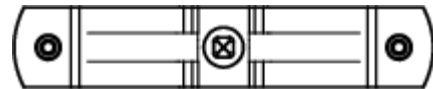

Technisches Datenblatt

**REGENSTANDROHRSCHELLE MIT
SCHLAGSTIFT**

Art.-Nr.: 97566
Nenngröße [mm]: 80/140
Material: Kupfer
Gewindegröße: 6

**Maße [mm]:**

A	B
87	140

Hinweis:

Passend zu Standrohr DN 80